

# Trex® W/ Horizons

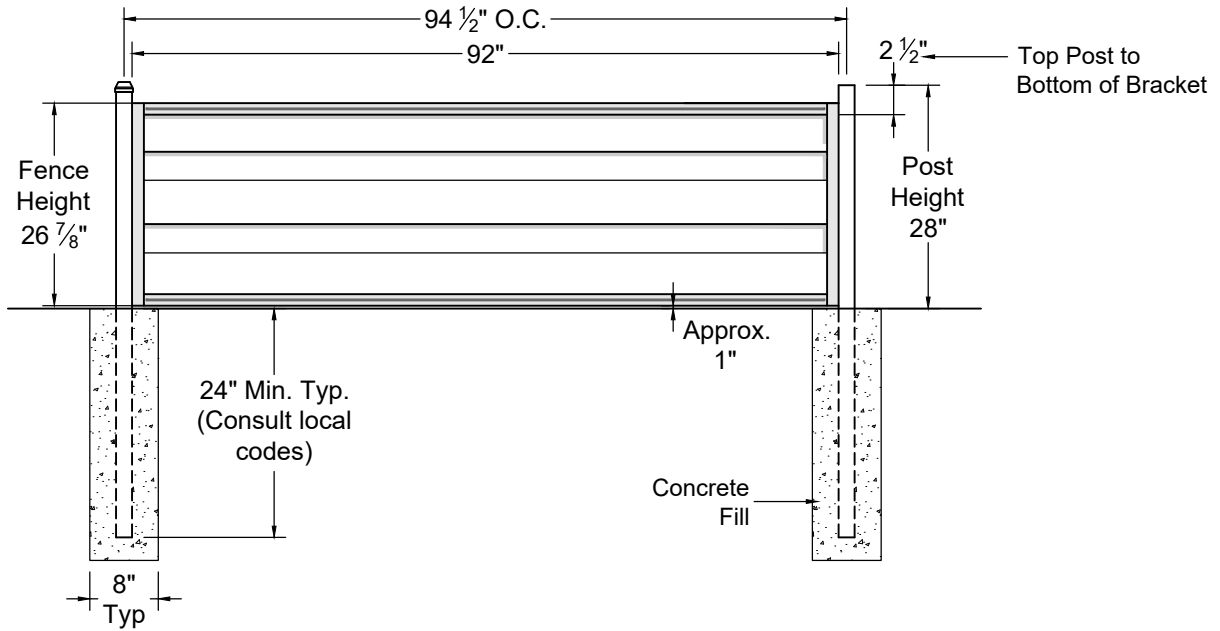





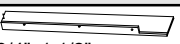

HORIZONTAL FENCE SYSTEM

**Fence Height: 2'**  
WITH 2 1/2" STEEL POSTS

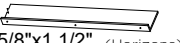

**NOTES:**

1. ALL HORIZONS COMPONENTS ARE MATTE BLACK POWDER COATED GALVANIZED STEEL.
2. INSTALLATION TO BE COMPLETED PER MANUFACTURER'S SPECIFICATION.
3. REFER TO [YourNextFence.com](http://YourNextFence.com) FOR CONSTRUCTION DETAILS AND PRODUCT INFORMATION.
4. DRAWING NOT TO SCALE.

COMPONENT	QTY.	LENGTH	COMPONENT	QTY.	LENGTH
Steel Post Cap 	1	N/A	Vertical Back Rail * (2-26") 	1	73 1/2"
Steel Post  2 1/2" x 2 1/2" (Horizons)	.5	108"	Vertical Front Rail (2-26") 	1	73 1/2"
Horizontal Rail  1 1/2" x 1 1/4" (Horizons)	2	92"	Horizontal Top Rail Bracket  1 1/4"x1" (Horizons)	2	1"
Bottom Rail / Picket  1" x 5 3/4"	5	91"	Screws  Pan-Head #10 38 3/4"  Self-Drilling #8 12 3/4"		

Component lengths may vary

\*Cut 2 pieces, 1 from each end.

