

Installation Guide:

**Trex**<sup>®</sup> w/ **Shenandoah**<sup>™</sup>  
RAIL FENCE SYSTEM



**Fence Distributors**

[TrexFencingFDS.com](http://TrexFencingFDS.com)



# Installation Guide:

# Trex<sup>®</sup> w/ Shenandoah<sup>™</sup>

RAIL FENCE SYSTEM

## Rail Fence Parts List

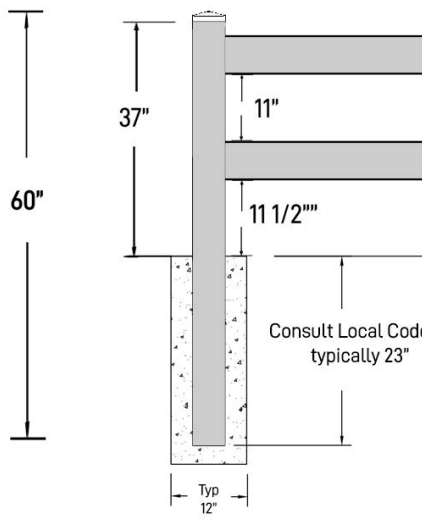
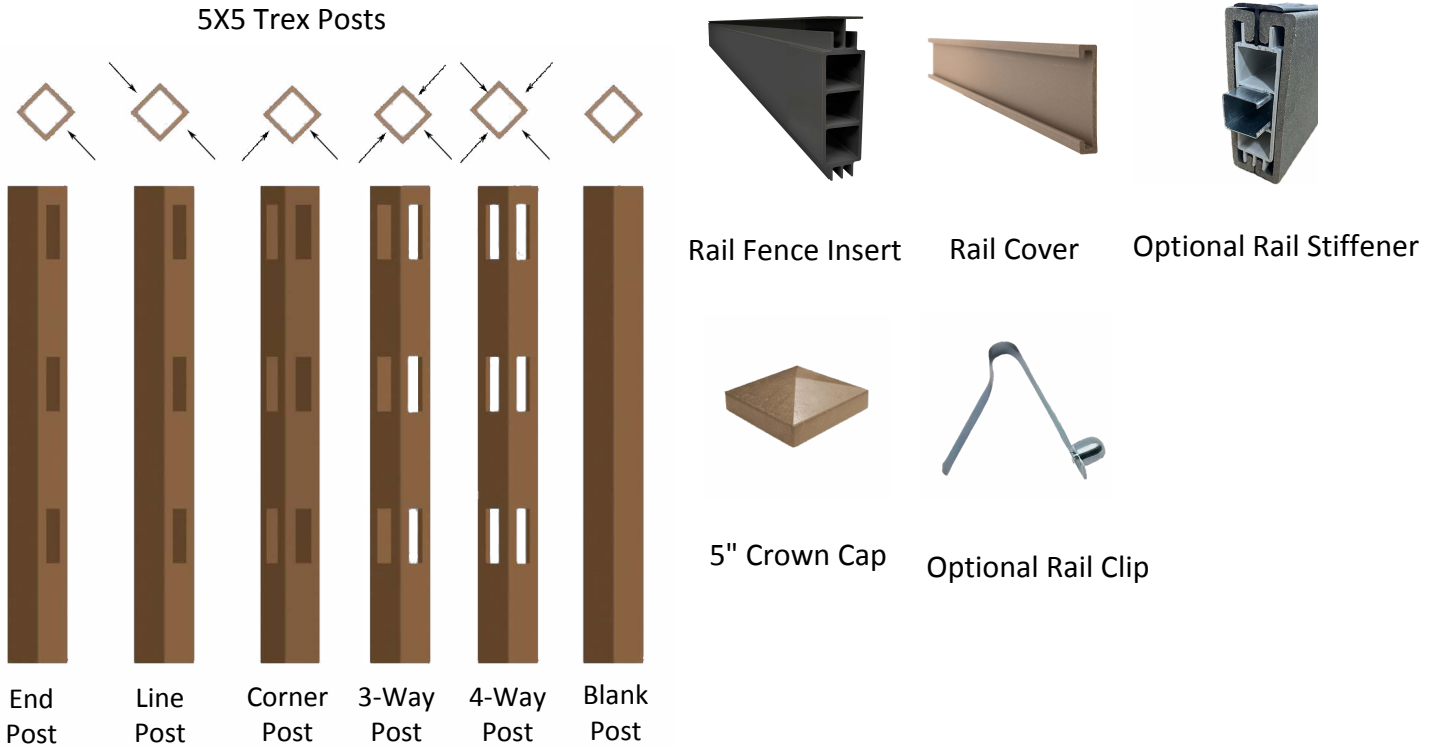

2-Rail

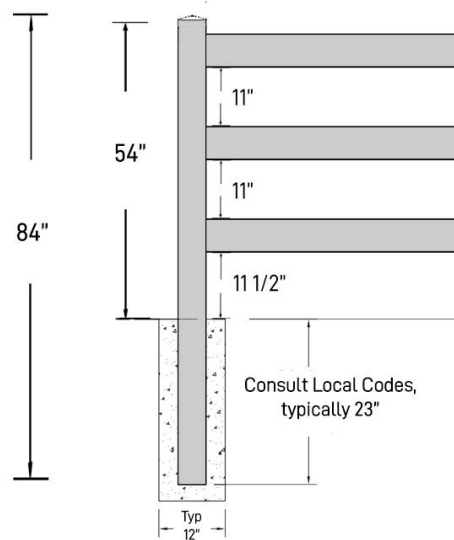

3-Rail

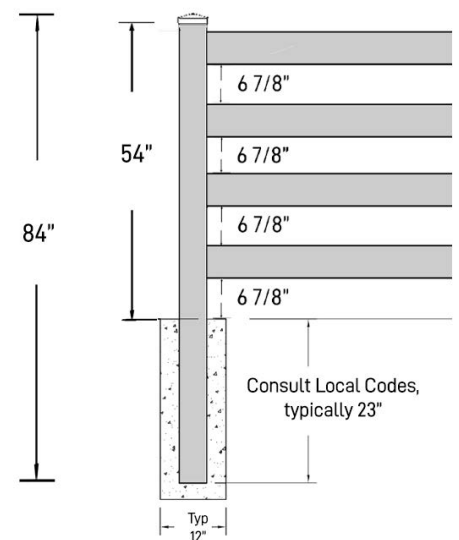

4-Rail

## Stake and String

1. Stake and String fence lines. Drive stakes approx. 2 ft. beyond property pins so that stakes will not be disturbed when digging holes, and approx. 4-5 inches inside of property pins to insure no encroaching on neighbors.
2. Mark Location of Posts. Spray paint a line perpendicular to the string every 92 1/4" on center. Spray additional lines (making a cross) 2" in from the string to mark the center of the hole (see Fig. 1).

Note: Laying out posts 92 1/4" on center may leave an odd section at the end. For a more uniform look, fence lines may be divided into even sections less than 92 1/4" on center. However, post layout should not exceed 92 1/4" from center of post to center of next post or rails will be too short. Ex: if fence line is 68 ft. long, posts would be spaced 90.2" on center ( $68' \times 12" = 812" / 9 \text{ sec} = 90.2"$ ).

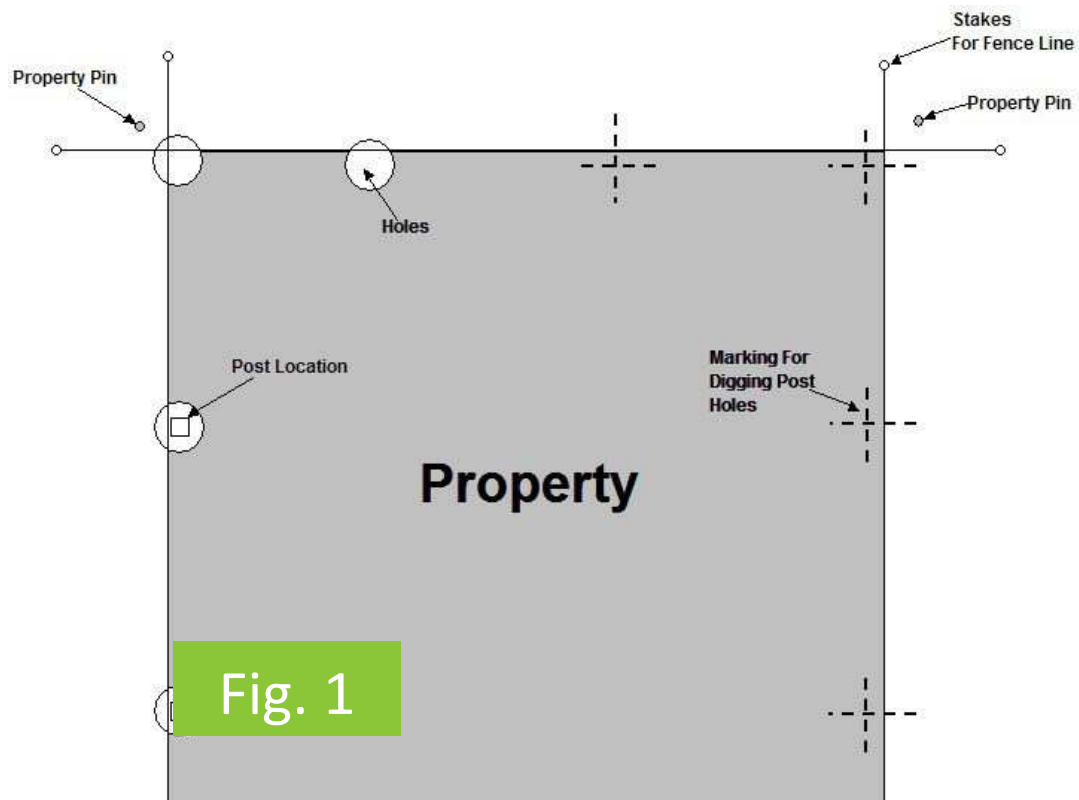

## Dig Holes

3. Dig holes for the posts making sure not to disturb the stakes for the string. The string may be removed and replaced after holes are dug. The holes should be approximately 12" in diameter and 30" deep for 3-4 Rail Fence or 23" for 2-Rail Fence (depending on local codes). Holes should be dug so that they allow equal amounts of concrete on all sides of posts (see Fig. 2).

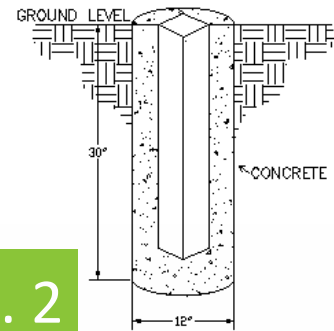

Fig. 2

## Set Posts

4. Begin by setting the end and corner posts. Plumb and level each post to the string line using a post level or 4' level. Make sure that the posts are next to but not pushing the string line. String a line from the top of each end post and set the remaining posts to this height. Fill the hole with concrete and brace if necessary until concrete is cured. Allow concrete to dry 24-48 hours (depending on temperature) before building (see Fig. 3)

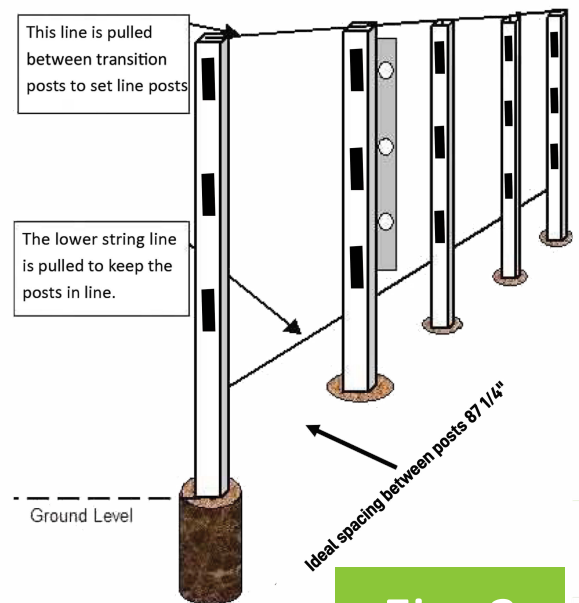

Fig. 3

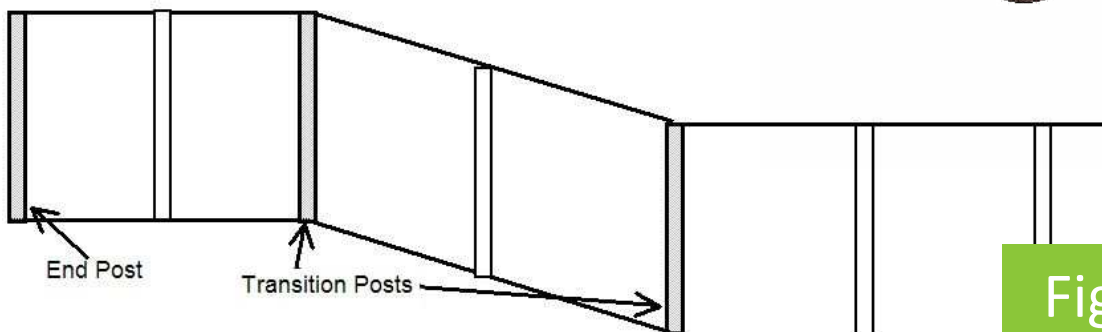

Fig. 4

If the fence is installed on a significant slope, the holes will need to be elongated using a jigsaw. Begin by setting all end, corner and transition (where grade changes) posts first. Posts should be 54" high for 3-4 rail fence, and 37" for 2-rail fence high. String a line from the top of these posts, then set the remainder of the posts to the height of the string (see Fig. 4). Dirt set transition posts first if needed the reset w/ concrete when completed.

## Cut Vinyl Ranch Rail Insert and Trex Sleeves

5. Hold each rail fence insert and Trex rail cover in place by pushing them against one post and mark the outside of the opposite post. Cut each rail 1/4" shorter than the mark to allow for expansion. The rails on corner posts will need to be cut shorter allowing them the other rails.

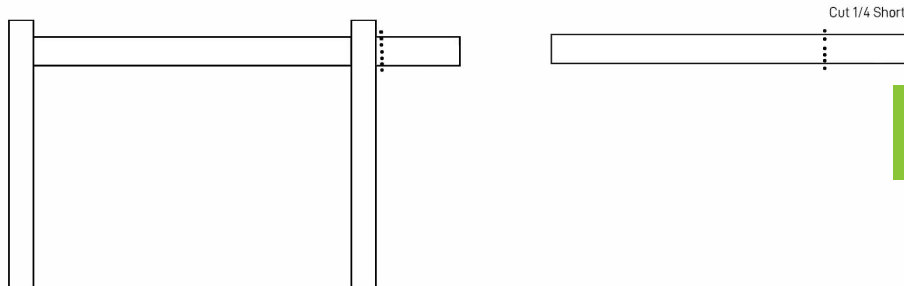

Fig. 5

6. Assemble the rails by sliding a Trex rail cover over each side of the rail fence insert (Fig. 6). Note: If using rail clips to secure rails, follow step 7 before installing rails.

If a stiffer rail is needed, cut and insert a steel rail stiffener (see Fig. 7) in the middle hole of the rail fence insert as shown. Slide the assembled rail into each post beginning from the end and working in one direction. Slide the rail into the opposite post first and slide back into the post with the rails already inserted. Leave a 1/4 gap between rails for expansion (Fig. 8).

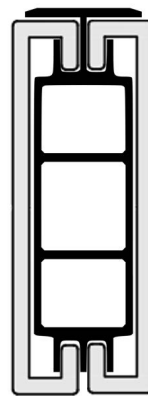

Fig. 6

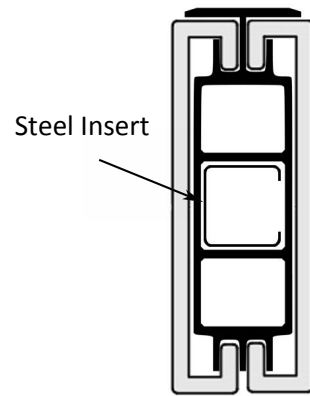

Fig. 7

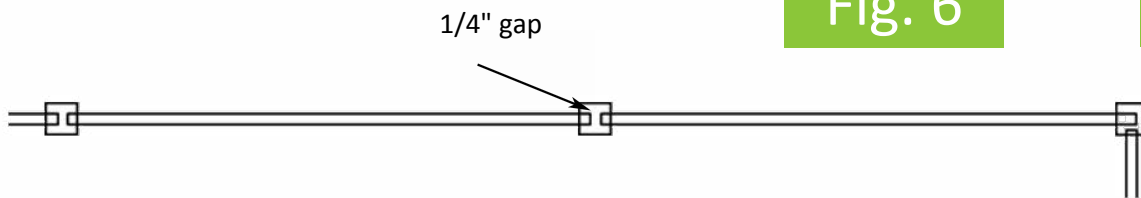

Fig. 8

## Securing Rails (Optional)

7. Follow one of the two options below to secure rails if needed.

A. Secure Rails using clips:

Drill a 9/16" hole on the end of each rail. Drill holes in location noted below.

The first hole will be on top facing you, the other hole will be drilled on the opposite side and end of the bottom rail.

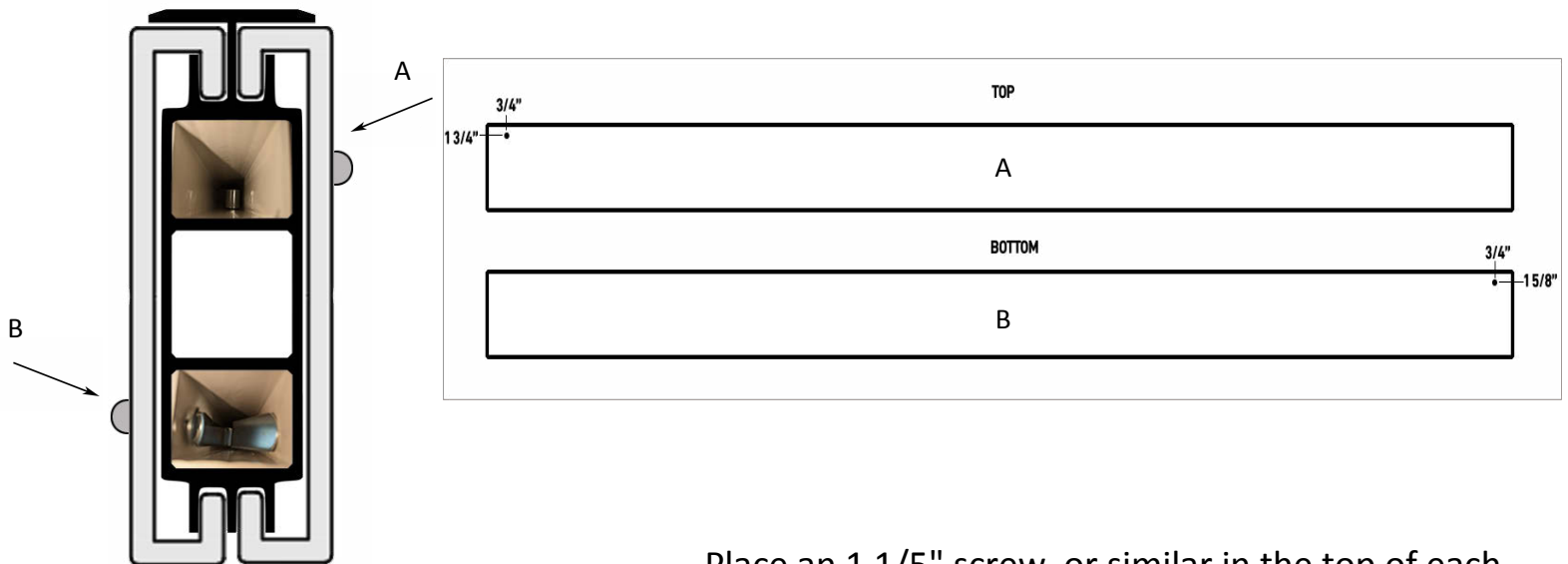

B. Secure Rails using screws:

Place an 1 1/5" screw or similar in the top of each rail as shown below and in the bottom of the middle and bottom rails.

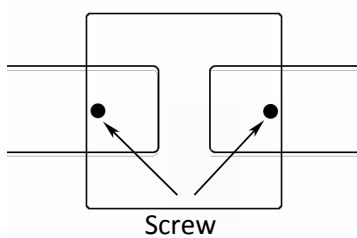

TOP VIEW INSIDE POST

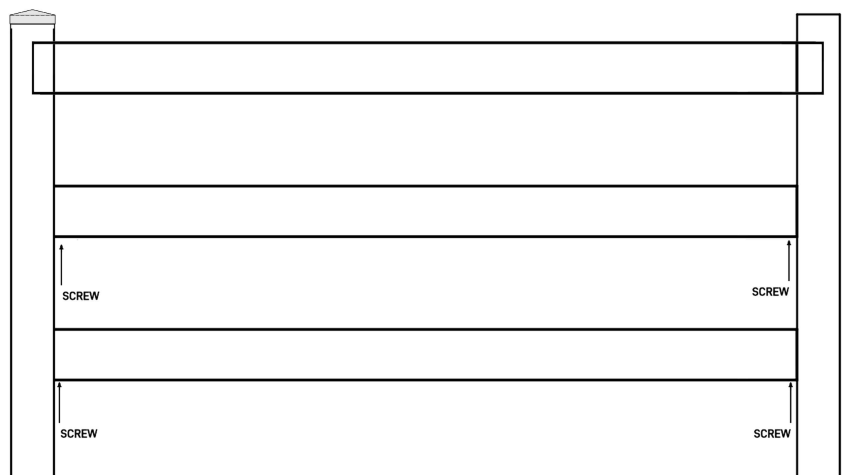

# Trex<sup>®</sup> w/ Shenandoah<sup>™</sup>

RAIL FENCE SYSTEM

## Attach Post Caps

8. Attach post caps using E 6000 adhesive available from most hardware stores or online.



Glue cap as shown

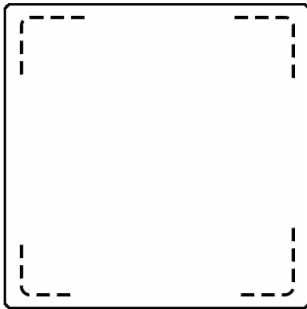

Place post cap on post

